



# **PDT Rack & Pinion Automatic Feed System**



\*Shown with Continental Tube Cut-Off Machine Model 3A

---

## **INSTRUCTION MANUAL**

---

Hymark Ltd. – 427 Bark Cove – Owensboro, KY 42303  
(270) 683-3500 – Fax (270) 683-2500  
[www.kentuckygauge.com](http://www.kentuckygauge.com)



**Identification Data**

Model	PDS
Serial Number	
Controller PartNumber	PS312P
Software Number	
Controller Serial Number	

**Customer Data**

Inventory-Number	
Location	

**Technical support and Spare Parts**

Hymark Ltd  
427 Bark Cove  
Owensboro, KY 42303  
USA

Phone (270) 683 3500  
Fax (270) 683 2500

Document Number of the Manual	
Version	
Date	
Last changings	

# Table of content

<b>1. Product Description</b>	<b>5</b>
1.1 <i>Intended use</i>	5
1.2 <i>Workplace</i>	6
1.3 <i>Danger zones</i>	6
1.4 <i>Technical specifications</i>	6
<b>2. Basic Safety Hints</b>	<b>7</b>
2.1 <i>Notice hints inside manual</i>	7
2.2 <i>Owner obligations</i>	7
2.3 <i>Operator obligations</i>	7
2.4 <i>Intended use</i>	7
2.5 <i>Warranty and liability</i>	8
<b>3. Safety Instructions</b>	<b>9</b>
3.1 <i>Symbol explanation</i>	9
3.2 <i>Organizational measures</i>	9
3.3 <i>Safety devices</i>	9
3.4 <i>Operator training</i>	10
3.5 <i>Position Controller</i>	10
3.6 <i>Safety measures</i>	10
3.7 <i>Danger by electrical power</i>	10
3.8 <i>Special danger zones</i>	11
3.9 <i>Maintenance and trouble shooting</i>	11
3.10 <i>Construction changes at the machine</i>	11
3.11 <i>Cleaning of the machine and disposal</i>	11
3.12 <i>Exposure to noise</i>	11
<b>4. Transportation</b>	<b>12</b>
4.1 <i>Installation location</i>	12
<b>5. Installation and Operation</b>	<b>13</b>
5.1 <i>Installation &amp; Operation procedures</i>	13-20
<b>6. Intended Gauge Use</b>	<b>21</b>
6.1 <i>Check before power on</i>	21
6.2 <i>Power on</i>	21
6.3 <i>Power off</i>	22
<b>7. Trouble Shooting</b>	<b>22</b>
<b>8. Maintenance</b>	<b>23</b>

# 1. Product Description

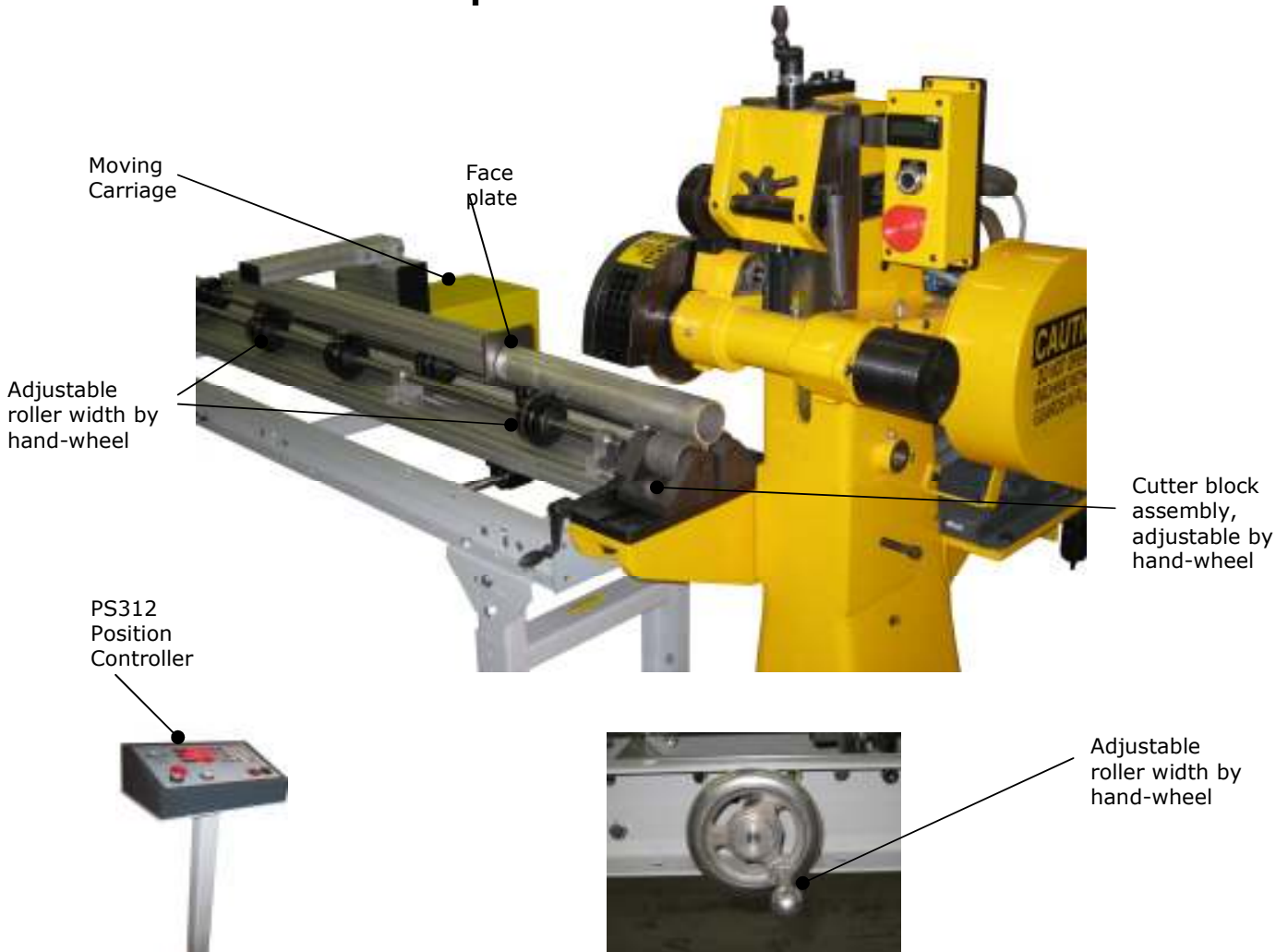

**Important Note: Your purchase of the Kentucky Gauge PDS tube feeder machine includes a set-up & operation instruction DVD video. Please review this video prior to setup & operation. A full PS312 position controller manual is also provided in a separate document.**

## General Operating Procedure of the Machine:

1. Place the tube to be cut on the tube feeding rollers with the tube cutting block preset to the required tube diameter. Change as needed with the cutter hand-wheel.
2. Using the PDS feeder hand-wheel, adjust the tube until it is level and Ensure that passing through cutting block is done in a level manner. Cutting the tube in a level position is critical for the cutter.
3. Select pre-entered program in the PS312 position controller.
4. Press start at the PS312 controller, the cutting sequence occurs.

### 1.1 Intended Use

The only acceptable use for the PDS is as a length gauging / feeder system. Any other use is not intended and is a misuse of the system.

## 1.2 Work Area

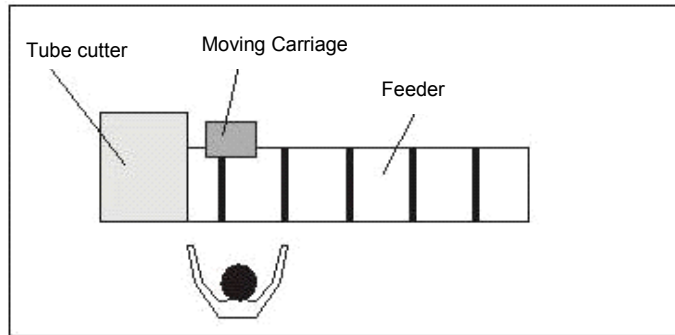

*Operator work area*

When the machine is powered on, the only acceptable operator location in the work area is standing in front of the control stand on the opposite side of the moving carriage (see picture above) Never place any material on the support stand that is not intended to be drilled.

## 1.3 Danger Zones

- The carriage
- The area between the face plate or carriage and the cutter
- The rollers zones (feeder and cutter)
- The cutter blade

These areas are always dangerous and have the potential to harm the operator or others. Please take special safety precautions when working inside these areas.

## 1.4 Technical Specifications

### General Data

Power supply for PS312 controller

110VAC, 6A

Current

Max 6A for 110VAC

Fuse positioning controller

6A slow-blow fuse 20 x 5 mm

Travel speed carriage max

16 inches / sec

Operating Temperature

+ 5° C to + 45° C (41°F to 113°F)

## **2. Basic Safety Hints**

### **2.1 Read and follow all hints inside the Instruction Manual**

Basic requirements for the correct use of the feeder system or the machine are the knowledge of the basic safety hints and the safety precautions. This instruction manual contains the most important safety hints.

- This instruction manual, especially the safety hints and precautions must be followed by every person working with this gauge or cutter machine.
- Also follow all general plant safety rules and precautions not mentioned in this manual.

### **2.2 Owner Obligations**

The owner agrees to only allow the machine to be used by qualified and trained persons who:

- Have been instructed in the general safety rules and precautions
- Have been instructed in the correct use of the gauge and cutter machine
- Have read and understood the safety chapters and caution hints of this instruction manual.

### **2.3 Operator Obligations**

All persons working with this feeder machine agree to the following before starting to work:

- Agree to follow the general safety rules.
- Agree to read and understand the safety chapters and caution hints of this instruction manual.

### **2.4 Intended Use**

The only acceptable use for this PDS is as a length gauging and feeding system. Any other use is not intended and is a misuse of the gauging system.

Hymark is not liable for any damages resulting from misuse.

Intended use also means:

- Following all safety hints and precautions mentioned in this manual
- Following the maintenance and inspection procedures as mentioned in this manual.

## 2.5 Warranty and Liability

Hymark Ltd Co (henceforth Hymark), warrants this product for a period of twenty-four (24) months from the date of shipment. During the warranty period, under authorized return component parts to Hymark freight prepaid, the company will repair, or at its option, replace any part found to be defective in material or workmanship, without charge to the owner for parts, service labor, or associated customary shipping costs.

This same protection will extend to any subsequent owner during the warranty period. It does not apply to damage caused by accident, misuse, fire, flood or acts of God, or from failure to properly install, operate, or maintain the product in accordance with the printed instructions provided.

This warranty is in lieu of any other warranties, expressed or implied, including merchantability or fitness for a particular purpose, which are expressly included. The owner agrees that Hymark's liability with respect to this product shall be set forth in this warranty, and incidental or consequential damages are expressly excluded

Hymark is not liable in part or in whole for any personal or equipment damage caused by of the following:

- Unintended use of the machine
- Improperly mounting, installing, maintaining or operating the machine.
- Operating the machine when the safety devices are damaged or not properly installed or if the safety or protection devices are not working properly.
- Disregarding the hints, notes and warnings concerning the transportation storing mounting installing using or maintaining the machine.
- Changing the construction or assembly of the machine.
- Replacing the original motor or other components or changing the load bearing components of the machine.
- Not monitoring the machine parts that wear.
- Improper repair or replacement.
- Acts of God or damage caused by impact of materials not involed in machine operation.



### 3. Safety Instructions

#### 3.1 Symbol and Hints Explanation

In this manual the following symbols are used:



##### **Danger!**

This symbol means an immediate impending life threatening or personal injury possibility if caution is not taken.

- Not following these hints can cause major injury.



##### **Danger by electrical power!**

This symbol warns of an immediate life threatening or personal injury risk by electric shock if the warning is not followed.

- Not following these hints can cause major injury.



##### **Caution!**

This symbol means that there is a possibly dangerous situation may occur.

- Not following these warning may cause personal or device damage.



##### **Important!**

These symbols give important hints for proper operation of the machine.

- Not following the these warnings can cause the machine to operated improperly.



##### **Note!**

Under this symbols you get user hints and other special use of the machine for optimal use of the machine functions.

- Following these hints will help with the optimal machine usage.

#### 3.2 Owner Responsibilities

The owner is responsible for any necessary personal protection equipment need for safe operation of the machine.

The owner is responsible for the correct function of any and all safety devices.

#### 3.3 Safety Devices

Before any operation of the machine all safety devices must be installed properly and tested.

Safety devices may be removed only

- when the machine is at a standstill
- after making sure that the machine cannot be run (i.e. removing power to the controller or main power box).

When any component of the machine is replaced or removed the safety devices must be properly installed and tested.

### 3.4 Operator Training

Only trained personel can operate the machine.

The training requirements for assembling, operating, maintaining the machine must be clearly defined. Personel in training, must be accompanied by trained personel.

Personel	Trained operators	Mechanically trained personel	Electrically trained personel
Job function			
Operating	X	--	--
Troubleshooting	X	X	X
Repairing	X	X	X
Maintainance	--	X	X

X...allowed --...not allowed

### 3.5 Position Controller

- Only trained personel are allowed to use the position controller.
- Only personel with electronic training are allowed to open the position controller.

### 3.6 Safety Measures for Machine Use

- Only operate the machine when all the safety devices are working properly and have been fully tested.
- Before applying power be sure that noone can be harmed by machine movement or operation.
- The machine should be checked at least once a day to check for recognizable damage and proper function.

### 3.7 Danger by Electrical Power

- Only properly trained and qualified electrical personel can work on the power supply.
- Check electrical devices frequently
- Immediately replace any loosed connection or cables that show wear.
- All electircal panels keys and controller access codes must be stored in a secure area with restricted access to unauthorized personel.

### **3.8 Special Danger Zones**

- The Carriage and Cutting areas.
- The Rollers zone on Feeder and cutter.

### **3.9 Maintenance and Troubleshooting**

- Follow the maintenance and inspection schedule.
- All operating mediums (i.e. air pressure) must be secured against unintentional activation.
- Unplug power cord any time for maintenance or repair.
- Check all bolts if tightened correctly.
- After finishing with maintenance check all safety devices before running the machine.

### **3.10 Machine Design Changes**

- Do not change any mechanical or electrical components of the machine without written manufacturer permittance.
- Replace all non-working or damaged electrical components and machine parts immediately.
- Use only original parts and equipment from the manufacturer.
- There is no warranty or liability if parts and equipment from different suppliers are used.

### **3.11. Machine Cleaning and Disposal**

Handle any lubricants properly especially

- When working with grease
- When working with chemicals.

### **3.12. Exposure to noise**

- Safety and protection devices such as ear plugs or head phones may be necessary

## 4. Transportation of the gauge



### **Danger!**

Danger caused by moving loads. Immediate impending life threatening or personal injury possibility by moving and dropping the gauge with a crane.

Don't stay underneath the lifted gauge.

The minimum age for operating personal is 21 years.

- Personal has to be authorized and trained before using a crane, a forklift or any other transportation vehicle

- ☞ Avoid bumping the Feeder during transportation as damage may occur.
- ☞ Use a crane or a vehicle with allowed maximum weight of 1500lbs.
- ☞ Move machine only at slow speed.
- ☞ Do not drive on any ramp while moving the machine.

### **4.1. Installation Location**

The load carrying capacity of the floor must be minimum 300lbs per square meter.

## 5. Installation



### **Danger!**

Danger caused by second or additional personal while testing and running the drill. Immediate impending life threatening or personal injury possibility if caution is not taken.

Before installation and while running the machine ensure that no other person is within the danger areas of the gauge



### **Note!**

Before installation, please check the machine for any damages or defects.

Eliminate any damage or defect before installing or running the machine or contact the manufacturer.

### 5.1 Installation procedure



**Note: The PDS Feeder should arrive in a form of partially assembled. The Continental cutter will be on a separate pallet. Please remove the machine(s) and accompanying parts from the box or crate carefully, ensuring no damage or accidental loss of the parts in packing material discard.**

### 5.1.1 Placement and leveling

- ☞ Place the Continental cutter in the desired location for operation. Please provide the power and air requirements as designated by Continental Tube / Kiene Diesel.
- ☞ Level the cutter system using a level. It is critical to set the machine level for proper operation.
- ☞ Place the PDS Feeder in a position as shown below (pushing from left to right) and mount the connecting plate as shown to join the PDS Feeder and cutter.



- ☞ There are height adjustable support legs for the PDS Feeder that may be altered if to match working height.



- ☞ Once leveled and in the desired location, it is recommended to anchor the system to the floor.
- ☞ Tighten or check for loose bolts between the legs and stands and throughout the machine. Bolts may have come loose during transportation.

### 5.1.2 Setting up controller & connecting power requirements

- ☞ Locate and stand upright the pedestal style free standing, place in a desired location of operation. Note: this may be moved to a different location later as desired.
- ☞ Place the control box on top of the stand and secure mounting with (4) M4 mounting bolts (supplied) on the underside of the control stand plate

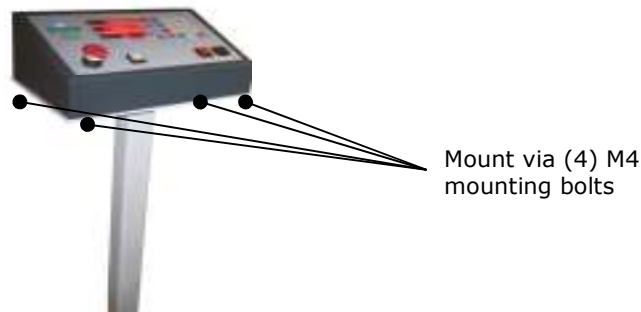

- ☞ Plug in power cable to position controller (standard PC Monitor cable to 110VAC, supplied).
- ☞ Plug in the remaining connections into the rear of the controller. Each connection is uniquely matched to the connector / cable lead. Depending upon your application, it may be the case that not all connectors on the rear of the panel are occupied.
- ☞ A full PS312 Position Controller Manual is provided in a separate document
- ☞ The power switch for the PDS Feeder is located at the rear of the PS312 controller. Both the cutter and the PDS Feeder need to be in the "ON" function in order to operate as a system.
- ☞ Optimization of the positioning ramps have been entered into the PS312 parameters. Please refer to the procedures inside PS312 position controller manual how to change controller functions.
- ☞ Please refer to the procedures inside PS312 position controller manual how to datum (reference the system).
- ☞ Please refer to the procedures inside PS312 position controller manual on how to enter a program for cut patterns / sequences.

### 5.1.3 Operation

- ☞ The PDS Feeder has an adjustable roller set to accommodate varying tube diameters. Adjust the roller width to accommodate a level pass thru line at the cutter block assembly of the cutter. Maintaining the tube in a level position is critical for the cutting process. The adjustment is done via use of the single handle crank arrangement.

Adjustable by  
loosening & tightening

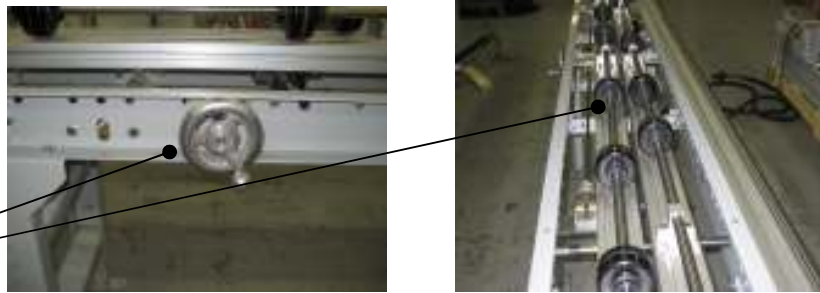

Ensure that the tube is  
level when passing thru  
roller set-up adjustment  
when changing tube  
diameters

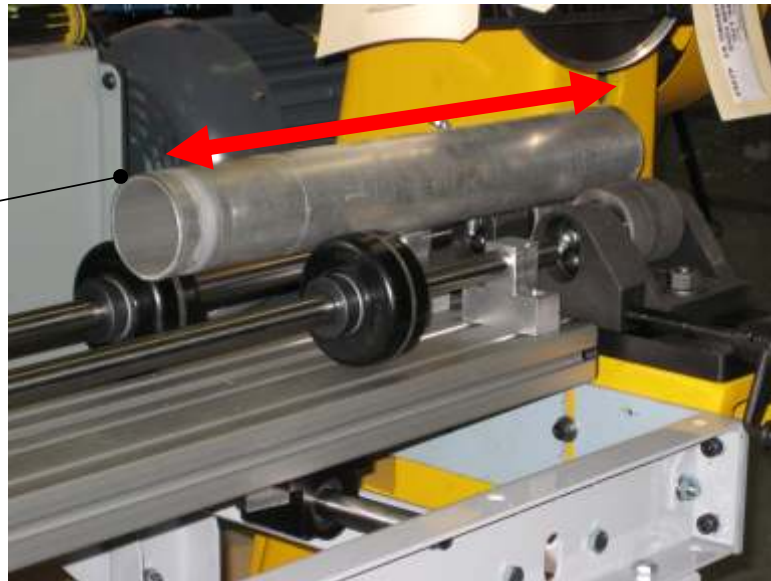

**TUBE MUST BE LEVEL**



- ☞ The individual rollers are adjustable to desired set positions for material rest. The adjustment is done via loosening and tightening bolts.

Adjustable by loosening, sliding to desire



- ☞ The function of the PDS feeder is to contact the back edge of the tube material and push the material through the cutter block to a demand position for cutting. The contact point for pushing is at the gauge face-plate. There is a photo eye located under the front edge of the PDS system to detect the leading edge of the tube.

Faceplate



Photo Eye

☞ The PDS controller (PS312) will send a “position reached” output to cycle the cutter. The carriage / faceplate will retract during the cutting process (cutter blade down) for free rolling tube process and return to normal position when the cutting cycle ends (cutter blade up).

**Carriage / faceplate will retract during the cutting process (W Hf blade down)**

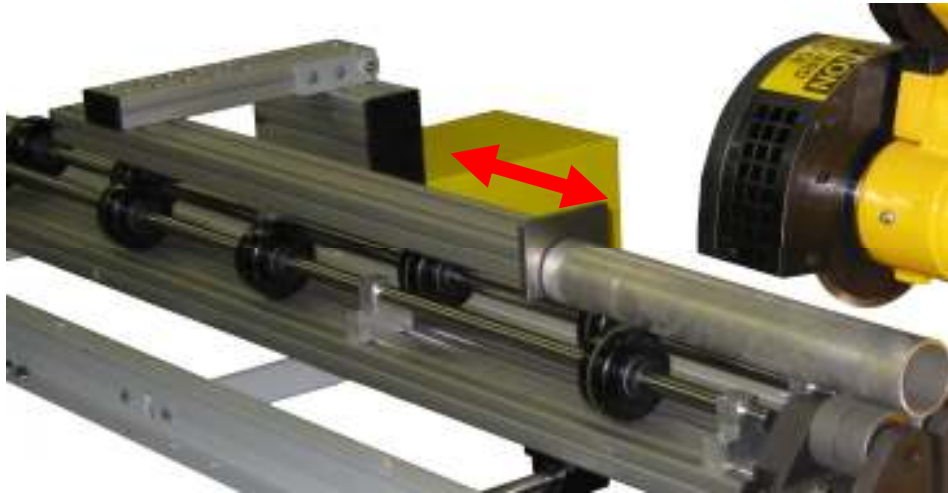

**Carriage / faceplate will return after / before cutting process (W Hf blade up)**

☞ The material is to be loaded by the operator one tube at a time with carriage / faceplate in home position (approximately 12ft from cutter). The operator selects desired program to run and presses start at the Kentucky Gauge controller. The carriage moves the tube with leading edge into cutting position for a trim cut if needed (trim cut skipped if not needed). There is a photo eye located under the front edge of the PDS system. This allows for the trim cut or initial cut to be produced upon leading tube edge detection. The first cut is initiated and then the programmed cuts occur automatically, pushing to the required distance and cycling the cutter producing finished parts until material is exhausted to remnant. Final position may be programmed to return to home or hold at final cut position for operator.

☞ Programs may also be downloaded via RS232 from a PC with provided TS312 software. Please consult TS312 manual for download procedures.

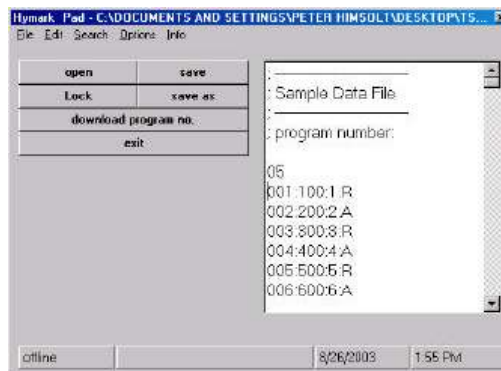

- ☞ Press the "Start" button to begin the PS312 programming. The cutter will be in an idle mode until the PS312 controller is initiated via it's "Start" button.
- ☞ Note: at any time, pressing the EMERGENCY STOP button will halt all PDS operations, including the controller function. The cutter has a separate EMERGENCY STOP button.



- ☞ With a pre-entered cut-list program loaded, select the program and press "Start" button. Please refer to the procedures inside PS312 position controller manual on how to enter a program for cut-lists.

## 6. Intended Machine Use

### 6.1 Check before turning power on



#### **Danger!**

Danger caused by devices on top of the support table.  
Personal injury possibility such as bruise etc.

- It is not allowed to place any parts or devices on the table, other than the part to be cut.



#### **Danger!**

Danger caused by second or additional personal while running the drill. Immediate impending life threatening or personal injury possibility if caution is not taken.

While running the machine ensure that no other person is within the danger areas of the gauge.



#### **Caution!**

Danger caused by wrong adjusted pneumatic device.

Personal injury possibility if air pressure is too high. Pneumatic cylinders might move faster and have more force.

- ☞ Do not allow unauthorized personnel to operate the machine or stand nearby.

### 6.2 Power "ON"



#### **Danger!**

Danger caused by stroke of the cutter.

Personal injury possibility such as bruise or cuts.

Reduce cylinder stroke speed by adjusting the valve.



#### **Danger!**

Danger caused by not wearing safety equipment like glasses and gloves.

Immediate impending personal injury possibility if caution is not taken.

### 6.3 Power "OFF"

- ☞ Turn power off by pushing the power button on the rear side of the controller housing.

- ☞ In any emergency situation push the red safety E stop button on the front side of the controller. Moving carrier will stop immediately.

- ☞ Pull the safety stop button to return to operating mode.

## 7. Troubleshooting

Malfunction	Possible reason	Possible corrective action
1. No display	<ul style="list-style-type: none"> <li>• Power off</li> <li>• Defect power cable</li> <li>• Damaged fuse</li> </ul>	<ul style="list-style-type: none"> <li>• Check power and power cable.</li> <li>• Check fuse of main power supply at the machine or inside the cabinet</li> <li>• Check fuse of the position controller on the rear side (next to power plug)</li> </ul>
2. Position controller is not accepting „Start“ anymore	<ul style="list-style-type: none"> <li>• Position controller is in „Quantity decrementing“ mode or „program entering“ mode</li> </ul>	<ul style="list-style-type: none"> <li>• Push <b>[Stop]</b> button</li> <li>• Exit „program mode“ by pushing : <b>[P]</b></li> <li>• Erase entered quantity by pushing : <b>[QTY]</b> and <b>[0]</b></li> </ul>
3. Length shown in the display of the controller and real measured length are different	<ul style="list-style-type: none"> <li>• Operator has redatumed the controller unintentionally</li> </ul> <p>Reader head mounted to carriage and magnetic tape mounted to aluminum extrusion are misaligned</p>	<ul style="list-style-type: none"> <li>• Datum the controller by pushing : <b>[R]</b>, datum value and <b>[R]</b></li> </ul> <p>Align reader head as shown below</p>

## 8. Maintenance

### 8.1 Safety Instructions



#### **Danger!**

Danger caused by devices on top of the roller table.

Personal injury possibility such as bruise etc.

- It is not allowed to put any parts or devices on the roller table.
- Only the part to be worked with can be on top of the roller table located only between machine and gauge arm, never on the other side.

### 8.2 Maintenance Requirements

Maintenance jobs as described in this chapter may only be done by authorized and trained personal.

### 8.3 Lubricants and Detergents

#### **Detergent**

- ☞ Use commercially available detergents.
- ☞ Don't use any acids or alkaline solutions
- ☞ Don't use any high pressure water jet cleaners

## 8.4 Maintenance Schedule

See chapter	Device	Cleaning	Lubricate	In addition	Frequency
8.5	Roller table	X	--	--	daily
8.6	Magnetic tape mounted to bottom side of aluminum extrusion	X			daily
8.7	Double steel rods on aluminum extrusion	X			

### 8.5 Cleaning the roller table

- ☞ Turn power off by pushing the power button on the rear side of the controller housing
- ☞ Remove chips and grease on the roller table.

### 8.6 Cleaning the magnetic tape

- ☞ Turn power off by pushing the power button on the rear side of the controller housing
- ☞ Remove chips and grease on the magnetic tape and between reader head and tape

### 8.7 Cleaning the double steel rods on aluminum extrusion

- ☞ You may clean with compressed air along the double steel rods.
- ☞ Add light machine oil lubricant in access of end cap labeled oil. This will keep wipers and steel rods maintained with lubricant. This may be checked on a quarterly basis or implemented in line with the standard preventive maintenance schedules.



- ☞ Any questions or inquiries should be directed to our factory technical department at 270-683-3500 ext.114.

Hymark Ltd. – 427 Bark Cove – Owensboro, KY 42303  
(270) 683-3500 – Fax (270) 683-2500