

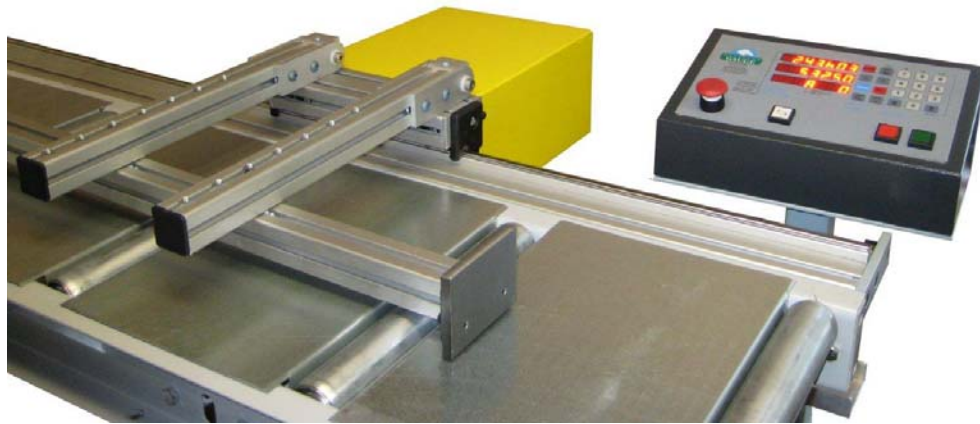

PD50 Rack & Pinion Automatic Gauge System



INSTRUCTION MANUAL

Hymark Ltd. – 427 Bark Cove – Owensboro, KY 42303
(270) 683-3500 – Fax (270) 683-2500
www.kentuckygauge.com

Identification Data

Model	PD50
Serial Number	
Controller PartNumber	PS312P
Software Number	
Controller Serial Number	

Customer Data

Inventory-Number	
Location	

Technical support and Spare Parts

Hymark Ltd
427 Bark Cove
Owensboro, KY 42303
USA

Phone (270) 683 3500
Fax (270) 683 2500

Document Number of the Manual	
Version	
Date	
Last changings	

Table of content

1. Product Description		5
<i>Intended use</i>	5	
<i>Workplace</i>		6
<i>Danger zones</i>	6	
<i>Technical specifications</i>		6
2. Basic Safety Hints		7
<i>Notice hints inside manual</i>	7	
<i>Owner obligations</i>		7
<i>Operator obligations</i>	7	
<i>Intended use</i>	7	
<i>Warranty and liability</i>	8	
3. Safety Instructions		9
<i>Symbol explanation</i>	9	
<i>Organizational measures</i>		9
<i>Safety devices</i>	9	
<i>Operator training</i>		10
<i>Position Controller</i>		10
<i>Safety measures</i>		10
<i>Danger by electrical power</i>	10	
<i>Special danger zones</i>	11	
<i>Maintenance and trouble shooting</i>	11	
<i>Construction changes at the machine</i>		11
<i>Cleaning of the machine and disposal</i>		11
<i>Exposure to noise</i>		11
4. Transportation		12
<i>Installation location</i>	12	
5. Installation		13
<i>5.1 Installation procedure</i>		13-22
6. Intended Gauge Use		23
<i>6.1 Check before power on</i>		23
<i>6.2 Power on</i>		23
<i>6.3 Power off</i>		24
7. Trouble Shooting		24
8. Maintenance		25

1. Product Description

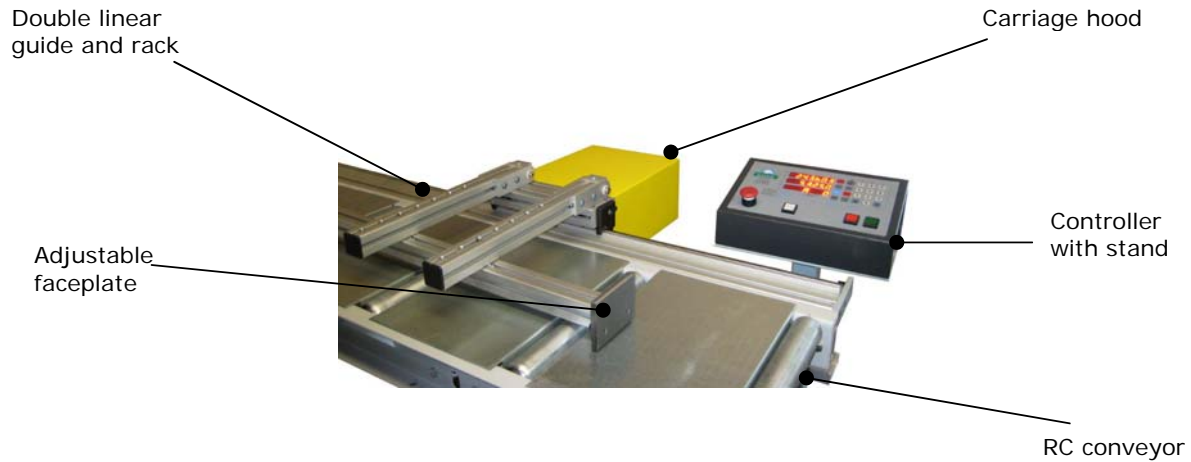

Note: Carriage length and depth can differ depending on motor and gearbox type

Operating Procedure (as "go to" stop)

1. Enter length to be cut into the position controller and press the Start Button. Gauge arm now moves into position.
2. Material is positioned through saw (or drill or punch) to desired length.
3. Engage the saw material clamp.
4. Retract gauge arm by pushing the Retract/Extend button.
5. Cut the material.
6. Remove the material.
7. Disengage the saw clamp.
8. Extend gauge arm by using the push button.

1.1 Intended Use

The only acceptable use for the PD50 is as a length gauging / feed system. Any other use is not intended and is a misuse of the gauging system.

1.2 Work Area

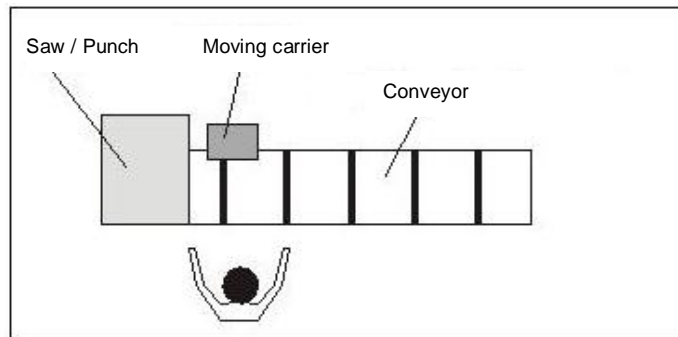

When the machine is powered on, the only acceptable operator location in the work area is standing in front of the control stand on the opposite side of the conveyor (see picture above) Never place any material on the conveyor except the piece to be cut.

1.3 Danger Zones

- The carriage
- The area between the face plate or carriage and the saw, drill, puncher or any other machines

These areas are always dangerous and have the potential to harm the operator or others. Use safety precautions when working inside these areas.

1.4 Technical Specifications

General Data

Weight	8 lbs per ft measuring length without conveyor
Travel speed	20in/sec (other upon request)
Power supply	115 V AC 60 Hz Input power 24 V DC Operating power
Current	Max 5 A
Fuse positioning controller	6A, slow-blow fuse 20 x 5 mm
Gauge arm extension	12 inches (others upon request)
Operating Temperature	+ 5° C to + 45° C (41°F to 113°F)

2. Basic Safety Hints

2.1 Read and follow all hints inside the Instruction Manual

This instruction manual, especially the safety hints and precautions must be followed by every person working with this gauge or machine.

Also follow all general plant safety rules and precautions not mentioned in this manual.

2.2 Owner Obligations

The owner agrees to only allow the gauge or the machine to be used by qualified and trained persons who:

Have been instructed in general safety rules and precautions
Have been instructed in the correct use of the gauge and machine

2.3 Operator Obligations

All persons working with this gauge and machine agree before operating:

To follow general safety rules
To read and understand this instruction manual.

2.4 Intended Use

The only acceptable use for this gauge is as a length gauging system. Any other use is not intended and is a misuse of the gauging system.

Hymark is not liable for any damages resulting from misuse.

Additionally:

Following all general safety rules and precautions mentioned in this manual
Following the maintenance and inspection procedures as mentioned in this manual.

2.5 Warranty and Liability

Hymark Ltd Co (henceforth Hymark), warrants this product for a period of twenty-four (24) months from the date of shipment. During the warranty period, under authorized return component parts to Hymark freight prepaid, the company will repair, or at its option, replace any part found to be defective in material or workmanship, without charge to the owner for parts, service labor, or associated customary shipping costs.

This same protection will extend to any subsequent owner during the warranty period. It does not apply to damage caused by accident, misuse, fire, flood or acts of God, or from failure to properly install, operate, or maintain the product in accordance with the printed instructions provided.

This warranty is in lieu of any other warranties, expressed or implied, including merchantability or fitness for a particular purpose, which are expressly included. The owner agrees that Hymark's liability with respect to this product shall be set forth in this warranty, and incidental or consequential damages are expressly excluded

Hymark is not liable in part or in whole for any personal or equipment damage caused by of the following:

- Unintended use of the gauge
- Improperly mounting, installing, maintaining or operating the gauge.
- Operating the machine when the safety devices are damaged or not properly installed or if the safety or protection devices are not working properly.
- Disregarding the hints, notes and warnings concerning the transportation storing mounting installing using or maintaining the machine.
- Changing the construction or assembly of the machine.
- Replacing the original motor with a stronger motor or changing the load bearing components of the machine.
- Not monitoring the machine parts that wear.
- Improper repair or replacement.
- Acts of God or damage caused by impact of materials not involved in machine operation.

3. Safety Instructions

3.1 Symbol and Hints Explanation

In this manual the following symbols are used:



Danger!

This symbol means an immediate impending life threatening or personal injury possibility if caution is not taken.

- Not following these hints can cause major injury.



Danger by electrical power!

This symbol warns of an immediate life threatening or personal injury risk by electric shock if the warning is not followed.

- Not following these hints can cause major injury.



Caution!

This symbol means that there is a possibly dangerous situation may occur.

- Not following these warning may cause personal or device damage.



Important!

These symbols give important hints for proper operation of the machine.

- Not following the these instructions can cause the machine to operated improperly.



Note!

Under this symbols you get user hints and other special use of the machine for optimal use of the machine functions.

- Following these hints will help with the optimal machine usage.

3.2 Owner Responsibilities

The owner is responsible for any necessary personal protection equipment needed for safe operation of the machine.

The owner is responsible for the correct function of any and all safety devices.

3.3 Safety Devices

Before any operation of the machine all safety devices must be installed properly and tested.

Safety devices may be removed only

- when the machine is at a standstill
- after making sure that the machine cannot be run (i.e. removing power to the controller).

When any component of the machine is replaced or removed the safety devices must be properly installed and tested.

3.4 Operator Training

Only trained personnel can operate the machine.

The training requirements for assembling, operating, maintaining the machine must be clearly defined. Personnel in training, must be accompanied by trained personnel.

Personnel	Trained Operators	Mechanically trained personnel	Electrically trained personnel
Job function			
Operating	X	--	--
Troubleshooting	X	X	X
Repairing	X	X	X
Maintenance	--	X	X

X...allowed --...not allowed

3.5 Position Controller

- Only trained personnel are allowed to use the position controller.
- Only personnel with electronic training are allowed to open the position controller.

3.6 Safety Measures for Gauge Use

- Only operate the machine when all the safety devices are working properly and have been fully tested.
- Before applying power be sure that nobody can be harmed by machine movement or operation.
- The machine must be checked at least once a day to check for recognizable damage and proper function of the safety devices.

3.7 Danger by Electrical Power

- Only properly trained and qualified electrical personnel shall work on the power supply.
- Check electrical devices frequently.
- Immediately replace any loosed connection or cables that show wear.
- All electrical panels keys and controller access codes must be stored in a secure area with restricted access to unauthorized personnel.

3.8 Special Danger Zones

- The Carriage and gauge arm.
- The interface zone between the machine and the gauge.

3.9 Maintenance and Troubleshooting

- Follow the maintenance and inspection schedule.
- All operating mediums (i.e. air pressure) must be secured against unintentional activation.
- Unplug power cord any time for maintenance or repair.
- Check all bolts if tightened correctly.
- After finishing with maintenance check all safety devices before running the machine.

3.10 Machine Design Changes

- Do not change any mechanical or electrical components of the machine without written manufacturer permittance.
- Replace all non-working or damaged electrical components and machine parts immediately.
- Use only original parts and equipment from the manufacturer.
- There is no warranty or liability if parts and equipment from different suppliers are used.

3.11. Machine Cleaning and Disposal

Handle any lubricants properly especially

- When working with grease
- When working with chemicals.

3.12. Exposure to noise

- The noise level produced by the gauging system is less than 70 dB (A).
- Special safety and protection devices such as ear plugs or head phones are not necessary for the gauge, but saws, drills and punches produce such noise levels requiring hearing protection.

4. Transportation of the gauge



Danger!

Danger caused by moving loads. Immediate impending life threatening or personal injury possibility by moving and dropping the gauge with a crane.

Don't stay underneath the lifted gauge.

The minimum age for operating personal is 21 years.

- Personal has to be authorized and trained before using a crane, a forklift or any other transportation vehicle

- ☞ Avoid bumping the gauge during transportation damage may occur.
- ☞ Use a crane or a vehicle with allowed maximum weight of 1500lbs.
- ☞ Move gauge only at slow speed.
Gauge might topple over if moved too quickly.
- ☞ Do not drive on any ramp while moving the gauge.

4.1. Installation Location

The load carrying capacity of the floor has to be minimum 300lbs per square meter.

5. Installation



Danger!

Danger caused by second or additional personal while testing and running the gauge. Immediate impending life threatening or personal injury possibility if caution is not taken.

Before installation and while running the machine ensure that no other person is within the danger areas of the gauge



Note!

Before installation check gauge for any damages or defects

Eliminate any damage or defect before installing or running the gauge. Contact the manufacturer if required.

5.1 Installation procedure



Note: carriage length and depth can differ depending on motor and gearbox type

5.1.1 Packing list

- one or two sections of aluminum guide with double steel rods and mounted rack (each section with pre-mounted T-nuts and bolts for missing joint rack)
- one bag with T-nuts, M8 bolts, washers and stand-offs to mount aluminum extrusion to conveyor
- one long piece of joint rack to connect both aluminum extrusion sections (only when shipped in two separate sections)
- one 10in long adapter rack piece with two squared metal spacers to properly align and tighten the separate joint rack with pre-mounted racks on aluminum guide sections (only when shipped in two separate sections)
- one motor carriage with yellow hood, stop arm with face plate
- cable track with cable and mating connectors to controller and carriage
- Sections of cable tray and mounting brackets with M8 socket head cap screws with washers and T-nuts
- free standing control stand (optional)
- Position controller

Important: *Please note that in some cases the machines are shipped fully assembled (or nearly assembled) and require less joining hardware. Contents may vary as application requires.*

5.1.2 Assemble Kentucky Gauge conveyor series (if conveyor is purchased)

- ☞ Place conveyor near saw, drill or punch
- ☞ Mount each height adjustable leg to the conveyor
- ☞ Level the conveyor using a level and the height adjustable bolts

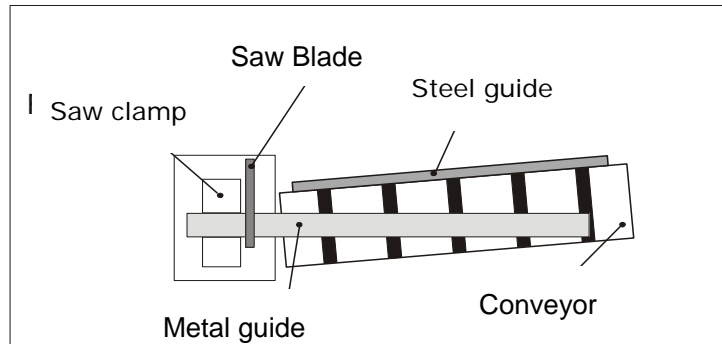

Adjust the conveyor so it is leveled lengthwise using a metal guide set in the saw clamp.

- ☞ Be sure the conveyor sections are straight and properly aligned. See below.

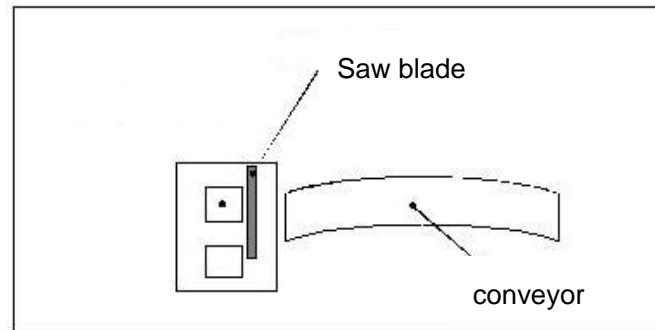

- ☞ Anchor the legs to the floor
- ☞ Tighten the bolts between the legs and the conveyor.

5.1.3 Mount aluminum guide section to conveyor

- ☞ Align the aluminum guide with the conveyor using a lift, saw horses, or some other appropriate means.

- ☞ Snap or slide T-nuts into the T-slot facing the conveyor. For the Kentucky Gauge conveyors series RC or RH use one T-nut every 18 inches (recommended). Note: T-nuts may already be inserted.



- ☞ Mount aluminum extrusion to conveyor by using M8 socket head cap screws with washers and stand-offs. Stand-off length is designed for Kentucky Gauge conveyors series RC and RH .



Note: Do not tighten the screws at this point to be able to align the T-nuts with the conveyor mounting holes and to align the aluminum extrusion in X direction when mounted to the conveyor

- ☞ When all stand-offs of first aluminum guide section are mounted adjust aluminum extrusion in X direction so that end of conveyor is aligned with end of aluminum extrusion and tighten socket head cap screws



5.1.4 Slide on carriage to aluminum guide

- ☞ Remove carriage hood by unscrewing the four flange head screws to have access to spring loaded servo motor with spur gear, motor set screw and mating connectors to attach cable inside track chain

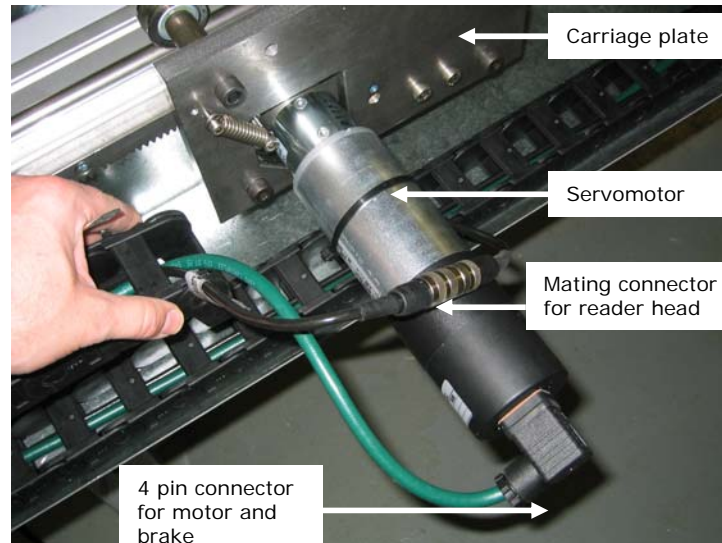

- ☞ Unscrew motor set screw to be able to push down motor with spur gear

Note: motor set screw may look different depending on type of motor and gear box

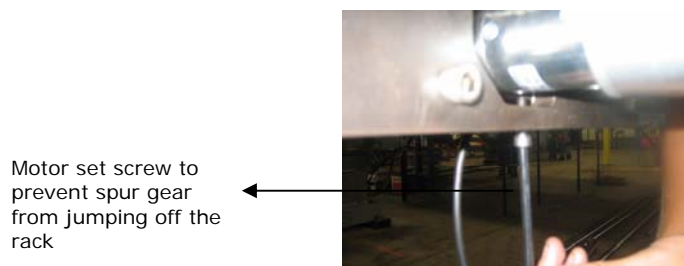

- ☞ Slide carriage carefully on aluminum extrusion so that the two top and bottom rollers of the carriage are running on the double linear guides, be sure to lift the wiper to allow for proper sliding

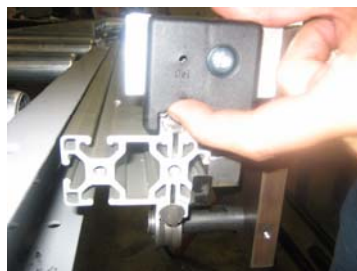



- ☞ Push down motor with spur gear to not hit pre-mounted rack screws and rack



- ☞ Release pushed down motor when spur gear has passed the rack
- ☞ Tighten motor set screw. Gap between end of screw and planetary gear box housing should not exceed 1/32in

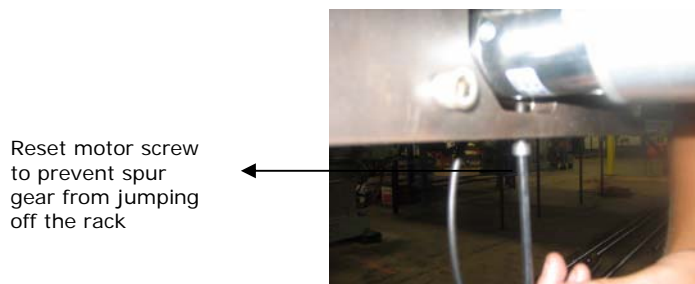

Systems long in length may require shipment and subsequent assembly in sections, please follow 5.1.5 and 5.1.6 for instructions (otherwise omit).

5.1.5 Mount 2nd aluminum guide section to conveyor

- ☞ Align 2nd section of the aluminum guide with the conveyor using saw horses and shims or some other appropriate means
- ☞ Snap T-nuts into the T-slot facing the conveyor. For the Kentucky Gauge conveyors series RC or RH use one T-nut every 18 inches (recommended). Make sure to slide on enough T-nuts to any section before mounting to conveyor
- ☞ Mount 2nd aluminum guide to conveyor by using M8 socket head cap screws with washers and stand-offs. Stand-off length is designed for Kentucky Gauge conveyors series RC and RH and might not work with different types of conveyors

Note: Do not tighten the screws at this point to be able to align the T-nuts with the conveyor mounting holes and to be able to mount the extra rack piece properly between both aluminum guide sections

5.1.6 Mount joint rack to aluminum guide sections

- ☞ Remove pre-mounted rack screws from 1st and 2nd section of aluminum guide



Pre-mounted screws to mount joint rack to connect aluminum guide sections

- ☞ Mount joint rack to 1st aluminum guide section by using the short adapter rack piece, the two metal spacers and a clamp

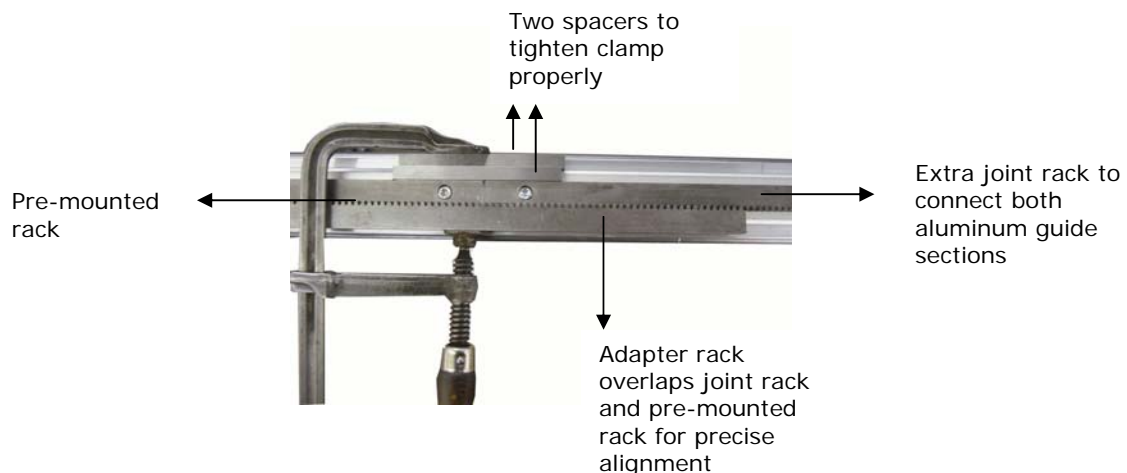

- ☞ Tighten all socket head cap screws of the joint rack on 1st aluminum guide section



- ☞ Release clamp and move adapter rack, spacers and clamp to the other end of the joint rack on 2nd section of the aluminum guide
- ☞ Mount joint rack to 2nd aluminum guide section and align joint rack with rack on 2nd aluminum guide by using again the adapter rack piece, the two metal spacers and the clamp
- ☞ Tighten all socket head cap screws of the joint rack on 2nd aluminum guide section
- ☞ Mount T-slot connecting plate between 1st and 2nd aluminum guide section to stabilize both sections. This T-slot connecting plate is located inside the bottom T-slot of 2nd aluminum guide section

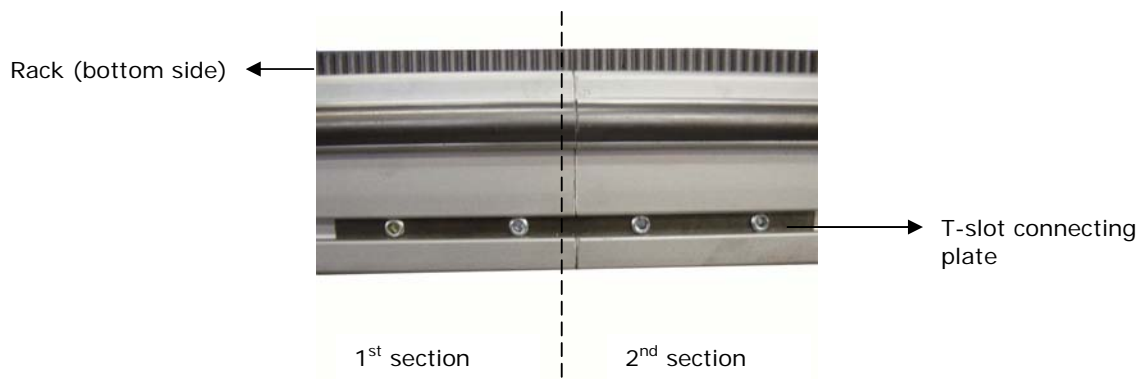

- ☞ Tighten now all socket head cap screws that connects conveyor with 2nd aluminum guide section

5.1.7 Mount cable tray sections to aluminum guide

- ☞ Required parts: cable tray sections (3" x 1" channel with brackets), T-nuts and M8 bolts with washers

- ☞ Slide on the brackets and secure loosely by using the bottom T-nuts in the slots of the aluminum extrusion. Align section 1 with far end of aluminum extrusion (opposite side of the saw, drill, punch, etc.)



- ☞ Space brackets properly at 8ft. Where channels meet, brackets will be placed in close proximity. Sections supplied in 16ft sections max. Fasten channels to brackets with provided hardware.

- ☞ Tighten the socket head cap screws of each section from underneath



5.1.8 Assemble cable and cable track to carriage

- ☞ Connect motor/brake and reader head cable from cable track to mating connectors on carriage

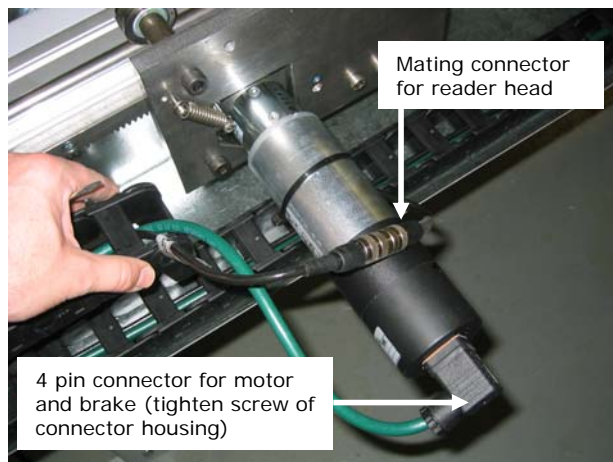

- ☞ Mount yellow carriage cover hood back on and snap in cable track to pre-mounted cable track bracket on carriage hood

Bolts for cable track bracket



5.1.9 Mount end of cable track to cable tray

- ☞ Slide conduit through U-cutout of section 4 and mount cable track bracket to section 3 of cable tray by using the two mounting holes

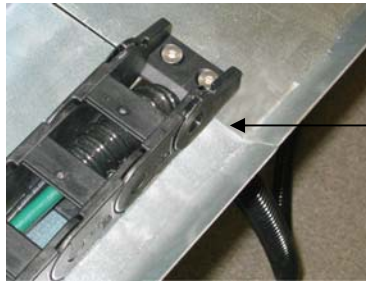

Cable track bracket

- ☞ Snap conduit into brackets



Bolts with washer and nuts

- ☞ Connect cables to back side of position controller
- ☞ Plug in power cable to position controller
- ☞ Follow procedures inside position controller manual how to datum and run the controller

5.1.10 Adjust stop arm and face plate

Adjustable stop arm in X, Y & Z direction

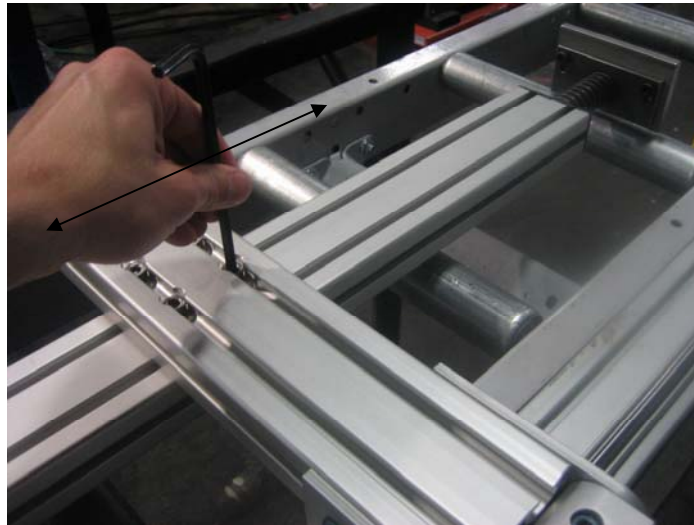

5.1.11 Mount gripper and pneumatics (optional)

Connect air line to hand valve and route through the cable track to pressure regulator

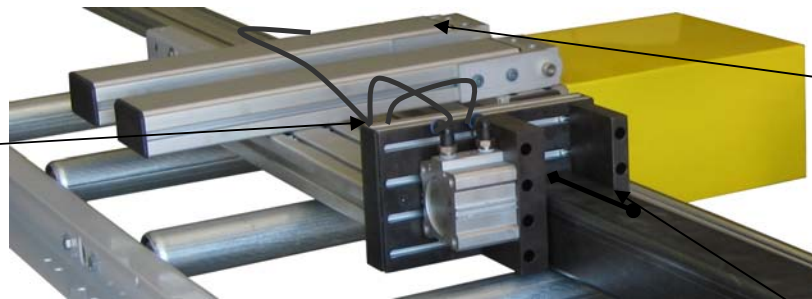

Bolt and T-nut locations to mount arm

Adjustable gripper for material types

☞ Connect air line to the hand valve through to the cylinder

☞ Route air line through cable track and connect to pressure regulator

6. Intended Gauge Use

6.1 Check before turning power on



Danger!

Danger caused by devices on top of the roller table.

Personal injury possibility such as bruise etc.

- It is not allowed to put any parts or devices on the roller table.
- Only the part to be worked with can be on top of the roller table located only between machine and gauge arm, never on the other side.



Danger!

Danger caused by second or additional personal while running the gauge. Immediate impending life threatening or personal injury possibility if caution is not taken.

While running the machine ensure that no other person is within the danger areas of the gauge



Caution!

Danger caused by wrong adjusted pneumatic device.

Personal injury possibility if air pressure is too high. Pneumatic cylinders might move faster and have more force

- Adjust air pressure to 116psi (8bar) before installation
- Check air pressure frequently before running the machine



Caution!

Danger caused by not using or improper use of the roller safety inserts

Personal injury possibility such as bruise or cuts.

☞ Do not allow unauthorized personnel to operate the machine or stand nearby.

☞ Do not put any material or parts on top of the roller table.

☞ Put on gloves and other safety devices.

6.2 Power "ON"



Danger!

Danger caused by stroke of the gauge arm.

Personal injury possibility such as bruise or cuts.

Reduce cylinder stroke speed by adjusting the throttle valve.



Danger!

Danger caused by not wearing safety equipment like glasses and gloves.

Immediate impending personal injury possibility if caution is not taken.

6.3 Power "OFF"

- ☞ Turn power off by pushing the power button on the rear side of the controller housing
- ☞ In any emergency situation push the red safety stop button on the front side of the controller. Moving carrier will stop immediately.
- ☞ Pull the safety stop button to return to operating mode.

7. Troubleshooting

Malfunction	Possible reason	Possible corrective action
1. No display	<ul style="list-style-type: none"> • Power off • Defect power cable • Damaged fuse 	<ul style="list-style-type: none"> • Check power and power cable. • Check fuse of main power supply at the machine or inside the cabinet • Check fuse of the position controller on the rear side (next to power plug)
2. Position controller is not accepting „Start“ anymore	<ul style="list-style-type: none"> • Position controller is in „Quantity decrementing“ mode or „program entering“ mode 	<ul style="list-style-type: none"> • Push [Stop] button • Exit „program mode“ by pushing : [P] • Erase entered quantity by pushing : [QTY] and [0]
3. Length shown in the display of the controller and real measured length are different	<ul style="list-style-type: none"> • Operator has redatumed the controller unintentionally <p>Reader head mounted to carriage and magnetic tape mounted to aluminum extrusion are misaligned</p>	<ul style="list-style-type: none"> • Datum the controller by pushing : [R], datum value and [R] <p>Align reader head as shown below, Sensor to scale gap must be within 0.1 to 2.0mm.</p>

8. Maintenance

Safety Instructions



Danger!

Danger caused by devices on top of the roller table.

Personal injury possibility such as bruise etc.

- It is not allowed to put any parts or devices on the roller table.
- Only the part to be worked with can be on top of the roller table located only between machine and gauge arm, never on the other side.

Maintenance Requirements

Maintenance actions as described in this document should only be done by authorized and trained personal that have become familiar with the Kentucky Gauge equipment. Any questions or inquiries should be directed to our factory technical department at 270-683-3500 ext.114.

Lubricants and Detergents

- ☞ Do not use acids or alkaline solutions
- ☞ Do not use high pressure water jet cleaners
- ☞ Use a light machine oil (i.e. "3 in 1" oil) where lubricating is needed

Maintenance items and frequency schedule

- ☞ Prior to any maintenance of the Kentucky Gauge or accessories, please ensure the machine is powered off by turning the power button to the "off" position on the rear side of the controller housing

Cleaning the roller table

- ☞ Remove chips and grease and any items that would be deemed in the pathway of, or causing an unwanted obstruction of, the gauge arm / carriage. This should be done several times per day when the machine is in use.

Cleaning the magnetic tape (under side of the guide rail)

- ☞ Remove chips and grease on the magnetic tape and between reader head and tape. This should be checked on a monthly basis to ensure there is no development of debris or obstruction. If heavy chip or debris accumulation occurs, increase frequency to accommodate suitable maintenance measures. The sensor to scale gap should be within the range of 0.1mm to 2.0mm

Cleaning and maintaining the carriage

- ☞ Do not remove any safety devices.
- ☞ Remove chips and grease and any items that would be deemed in the pathway of, or causing an unwanted obstruction of, the gauge arm / carriage. This should be done several times per day when the machine is in use.
- ☞ Ensure that the hardware connecting the gauge arm to the carriage and the cable track to the carriage are secured. This may be checked on a quarterly basis or implemented in line with the standard preventive maintenance schedules for the other equipment in the facility.

Cleaning the double steel rods on aluminum extrusion

- ☞ You may clean with compressed air along the double steel rods.
- ☞ Add light machine oil lubricant in access of end cap labeled oil. This will keep wipers and steel rods maintained with lubricant. This may be checked on a quarterly basis or implemented in line with the standard preventive maintenance schedules for the other equipment in the facility.



- ☞ Any questions or inquiries should be directed to our factory technical department at 270-683-3500 ext.114.

Hymark Ltd. – 427 Bark Cove – Owensboro, KY 42303

(270) 683-3500 – Fax (270) 683-2500